

UltraDish™ TP 24

PARABOLIC DISH ANTENNA WITH TWISTPORT™ CONNECTOR

UltraDish™ TP 24 is designed for subscriber module applications. Minimized sidelobes, wide frequency bandwidth, and stable gain in both polarizations assure dependable performance. Antenna reflector is made of aluminium to ensure a low weight and uniform shape. Our proprietary TwistPort™ waveguide connector enables intuitive radio connection and replacement.

Massive mount with improved grip and a wide range of applicable pole diameters makes the deployment easy and versatile. Stainless hardware comes with black coating to prevent from seizing at the installation.



Gain H

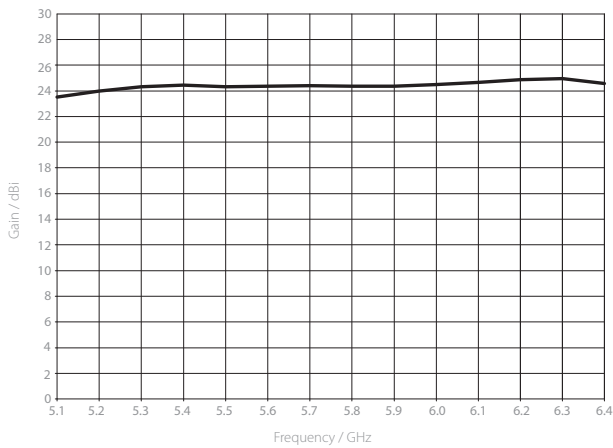

Azimuth Pattern H

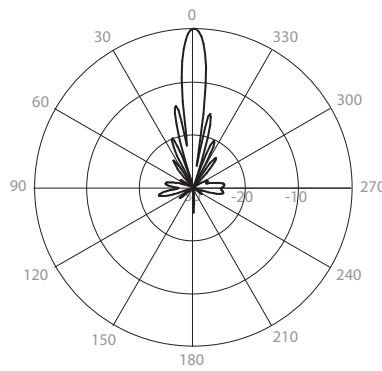

Elevation Pattern H

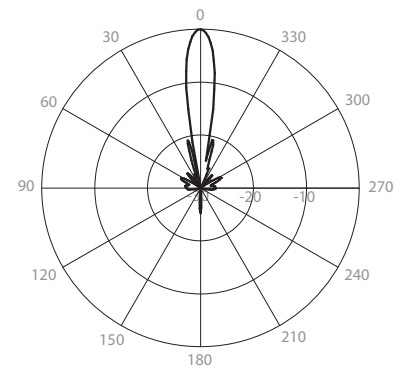

Gain V

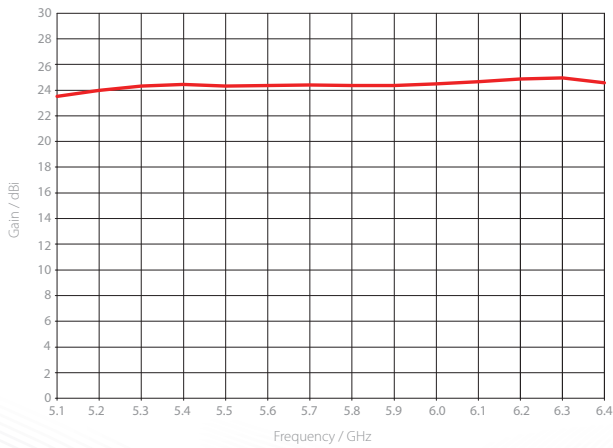

Azimuth Pattern V

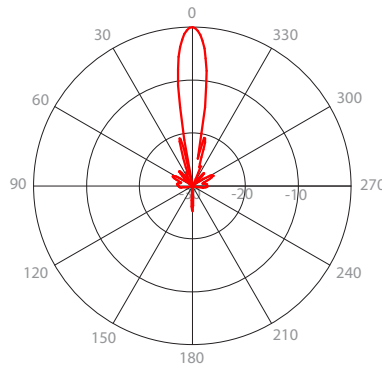

Elevation Pattern V

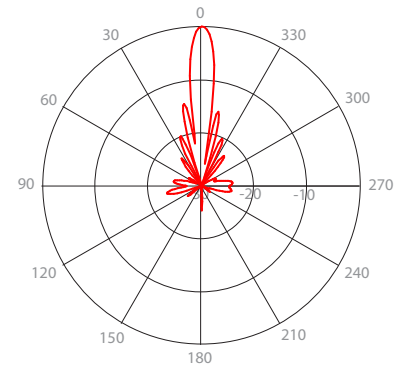

PHYSICAL

Antenna Connection	TwistPort™ - Quick Locking Waveguide Port
Antenna Type	Parabolic Dish
Materials	UV Resistant ABS Plastic, Polycarbonate, Aluminium, Stainless Steel
Environmental	IP65
Pole Mounting Diameter	40-80 mm (1.5-3.1 inch) Recommended as close to 80 mm (3.1 inch) as possible
Temperature	-40 °C to +60 °C (-40°F to +140°F)
Wind Survival	160 km/h (100 mi/h)
Wind Load	167/22 N - Front/Side at 160 km/h (100 mi/h)
Effective Projected Area	1372/176 cm ² - Front/Side (212.7/27.3 in ²)
Weight	2.7 kg (6 lbs) – single unit (one antenna)* 7.3 kg (16 lbs) – 2PACK (2 units) incl. package*
Dimensions	Retail Box 2PACK: 470 x 470 x 205 mm (18.5 x 18.5 x 8.0 inch)

PERFORMANCE

Gain	24.4 dBi
Frequency Range	5180 - 6400 MHz
Azimuth Beam Width -6 dB	H 12° / V 11°
Elevation Beam Width -6 dB	H 11° / V 12°
Azimuth Beam Width -3 dB	H 9° / V 8°
Elevation Beam Width -3 dB	H 8° / V 9°
Beam Efficiency**	40%
Front-to-Back Ratio (Min)	35 dB

COMPATIBLE WIRELESS PLATFORMS

- any TwistPort™ Adaptor
- any SIMPER™ Radio

PRODUCT DIMENSIONS

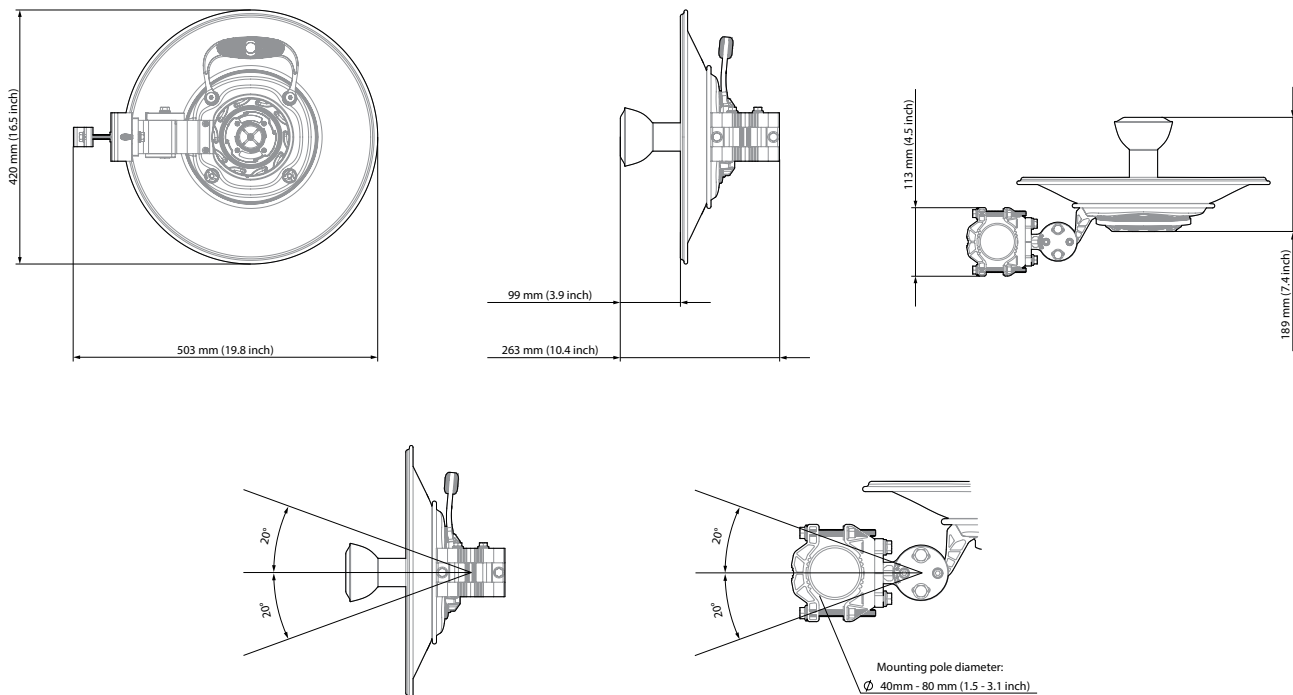

**Beam efficiency defined up to first null