

**NanoBracket®**

Light for RB SXT

BRACKET FOR ROUTERBOARD™ SXT



# NanoBracket® Light for RB SXT

1

## Package Contents

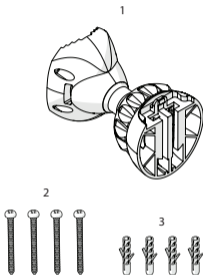

Number	Description	Quantity
1	NB Body	1x
2	3,5 x 45mm Screw	4x
3	Wall Plug	4x

Use hose clamp supplied with your RB SXT.

## Installation Guide

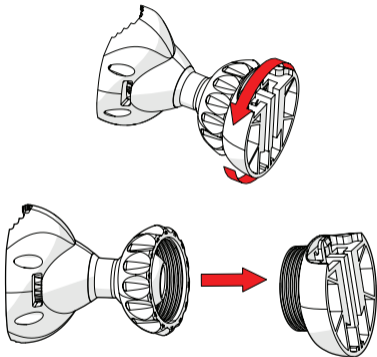

## Installation Guide

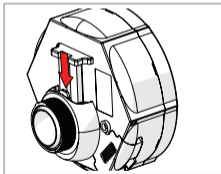
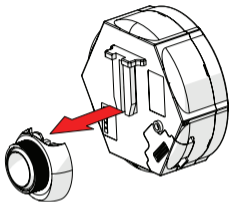

# NanoBracket® Light for RB SXT

4

## Pole Installation

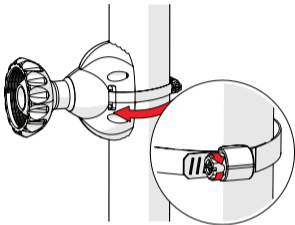

## Wall Installation

4x Screw 3,5 x 45mm

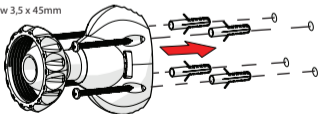

## Installation Guide

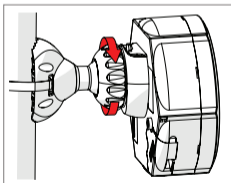
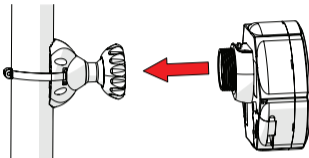

## Installation Guide

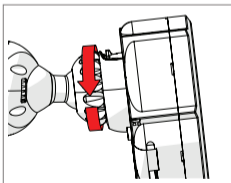
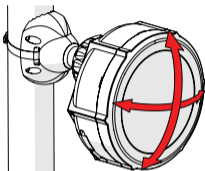

Compatible Devices:

**Mikrotik™**

SXT 5 ac

SXT SA5

SXT SA5 ac

SXT HG5

SXT HG5 ac

SXT Lite2

SXT Lite5

SXT 2

SXT 5

Mikrotik™ and RouterBoard™ are trademarks of Mikrotik, Aizkrauklesielā 23, Rīga, LV-1006 Latvia.

RF elements® and NanoBracket® are trademarks of RF elements s.r.o., Humenne, Slovakia.

All rights of trademark owners reserved.



RF elements s.r.o.

Phone: +421 2 3260 3711

info@rfelements.com

[www.rfelements.com](http://www.rfelements.com)