

UltraDish™ TP 550

DIRECTIONAL PARABOLIC DISH ANTENNA WITH TWISTPORT™ CONNECTOR

UltraDish™ TP 550's are designed for CPE or PtP connections. The antenna reflector is made from an aluminum alloy to ensure a very uniform shape. Our virtually lossless TwistPort™ connector guarantees easy radio deployment and maintenance.

Antenna installation is extremely easy and ensures rapid deployment for large scale projects. Our innovative antenna mount fits a wide range of pole diameters and can be easily swapped for right or left side mounts. A single HEX tool is all you need to perform your installation.



Gain H

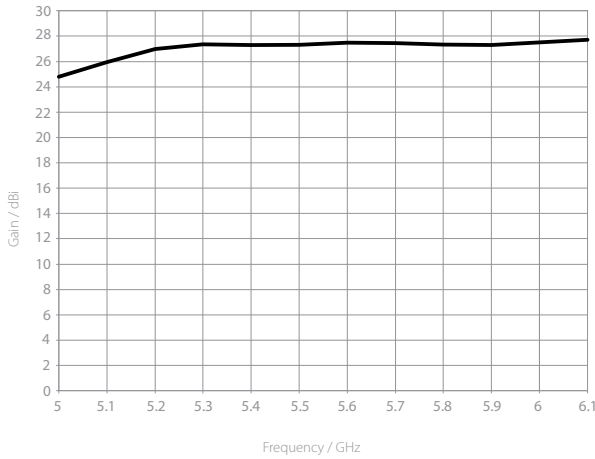

Azimuth Pattern H

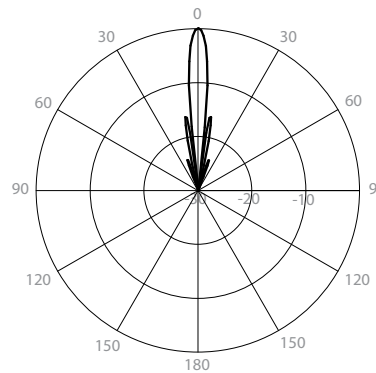

Elevation Pattern H

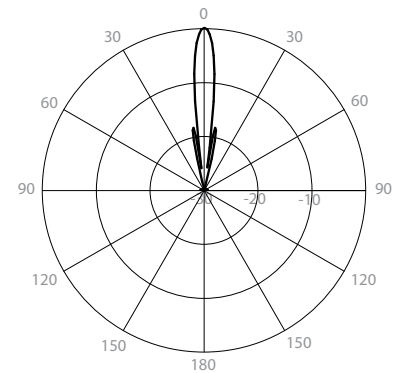

Gain V

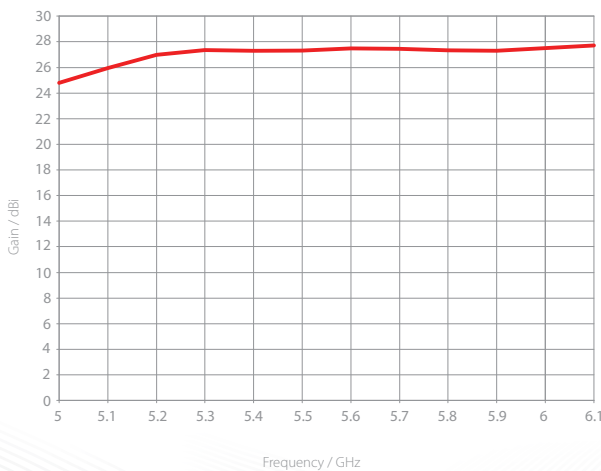

Azimuth Pattern V

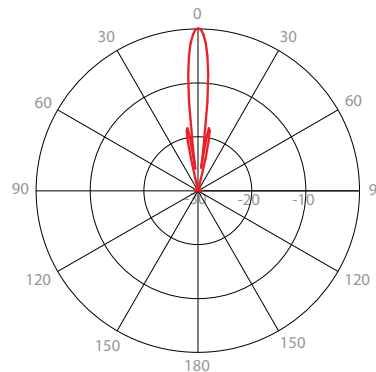

Elevation Pattern V

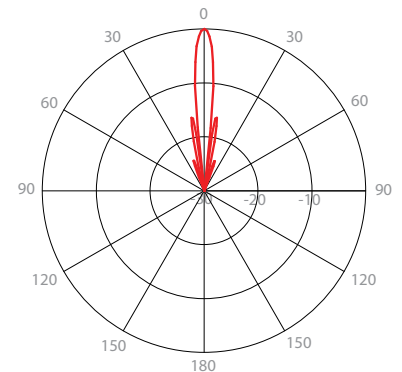

PHYSICAL

Antenna Connection	TwistPort™ - Quick Locking Waveguide Port
Antenna Type	Parabolic Dish
Environmental	IP65
Pole Mounting Diameter	25-80 mm (we recommend as close to 80mm as possible)
Temperature	-40 to +60 °C (-40°F to +140°F)
Wind Survival	160 km/hour
Wind Loading	324 N a 160 km/hour
Weight	3.7 Kg / 8 lbs – single unit (one antenna) 19.3 Kg / 43 lbs – 4PACK (4 units) incl. package
Dimensions	Retail Box 4PACK: 610 x 610 x 460 mm / 24.0 x 24.0 x 18.1 inch

COMPATIBLE WIRELESS PLATFORMS

any TwistPort™ Adaptor

any SIMPER™ Radio

PRODUCT DIMENSIONS

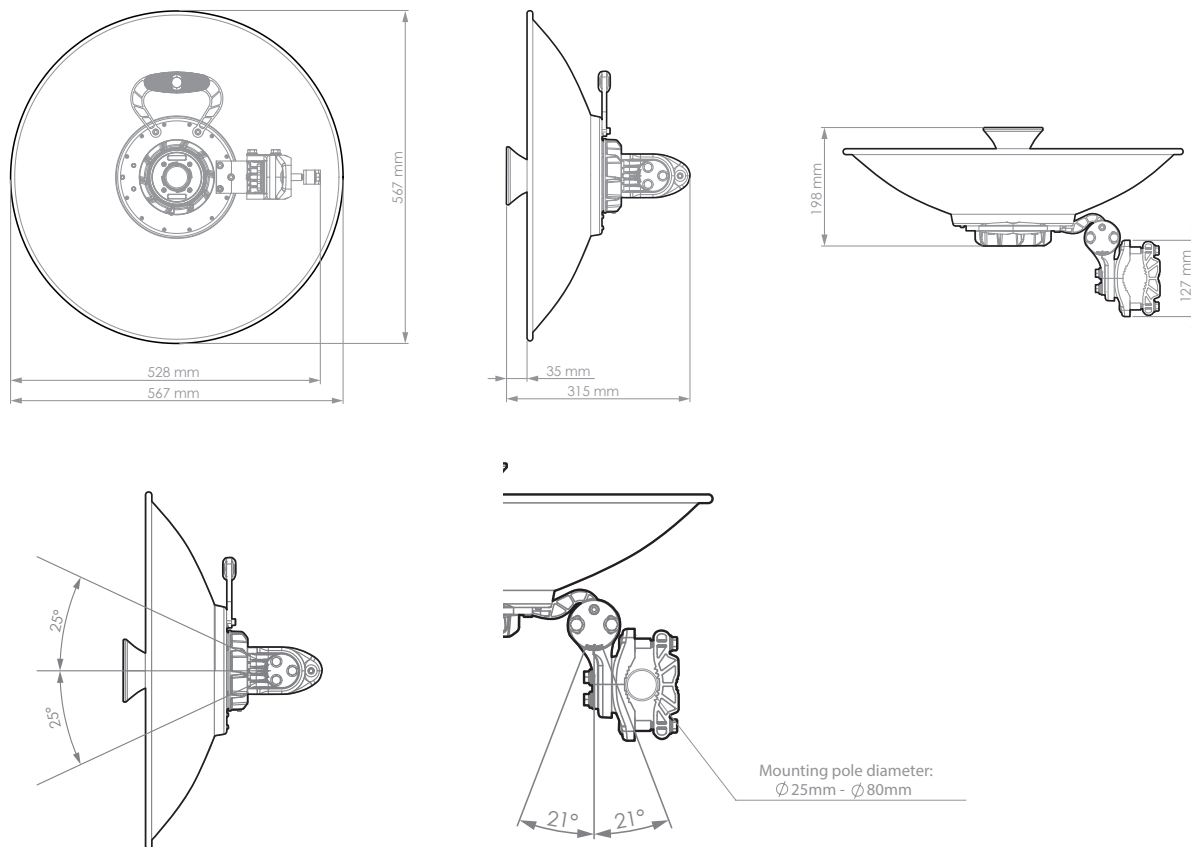

**Beam efficiency defined up to first null

3D RADIATION DIAGRAM

SCALE: 30dBi

COMPATIBLE WITH: ADOBE ACROBAT READER DC. NOT SUPPORTED ON MOBILE.

USE MOUSE TO ROTATE THE DIAGRAM. SCROLL IN/OUT TO ZOOM IN/OUT

dBi

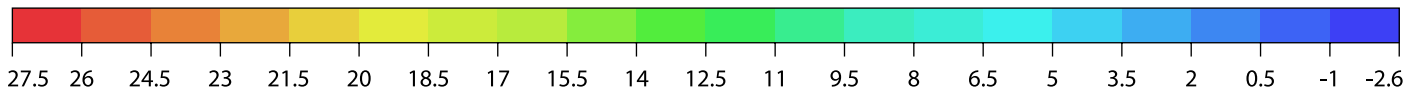

FRONT	BACK	RIGHT	LEFT	UP	DOWN
-------	------	-------	------	----	------